



Direction-Plus Fuel Manager Post-Filter Installation Guide for Ford Ranger PXIII

Fuel Manager Post-Filter Installation Guide

This document is to be used as a guide for the installation of the **Direction-Plus™ Fuel Manager Post-filter kit (PF664DPK)** to a **Ford Everest YNWS (2018-2022) and Ranger PXIII Bi-Turbo YNWS (2019-2022)**.

It is recommended that the installation of the product be carried out by a competent qualified mechanic.

Important before starting

- Ensure the engine bay is clean and free from contaminants.
- The filter head has direction arrows indicating the direction of flow.
- You have the correct tools to complete the fitment.
- Read the instructions in full and familiarize yourself with the installation before commencing any work.

Included in the kit

- 1 x Mounting Bracket A
- 1 x Mounting Bracket B
- 8 x Cable Ties
- 1 x M8x16 Bolt
- 2 x M8 Flat Washers
- 1 x M8 Stainless Steel Nut
- 1 x Fuel Manager FM100
- 2 x 10mm straight push lock hose fittings
- 2 x M16 x 1.5 adapters
- 2 x M16 flat washers
- 1 x Fuel hose 10mm
- 2 x 10mm hose clamps
- 2 x M10 bolt
- 2 x M10 nut
- 4 x M10 washers

Approximate mounting location

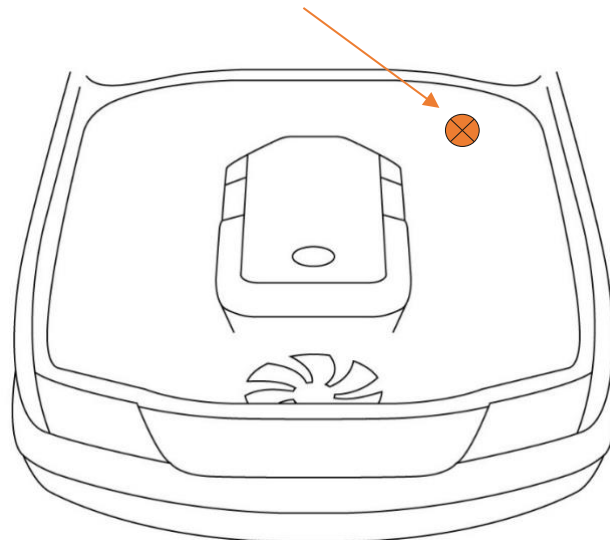

Kit contents are subject to change based on availability.

Fuel Manager Post-Filter Normal Flow Header Connection

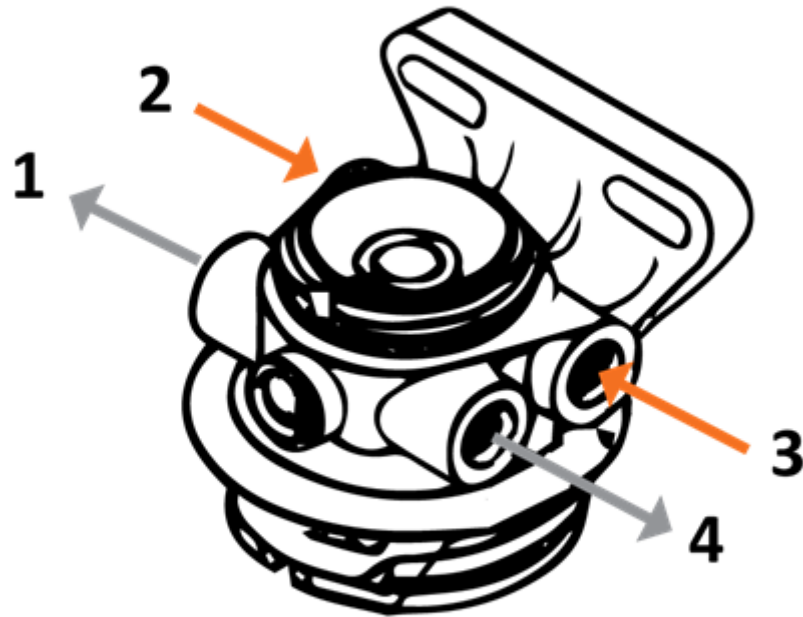

Ports 2 and 3 = INLET
Ports 1 and 4 = OUTLET

Fuel Manager Installation Guide

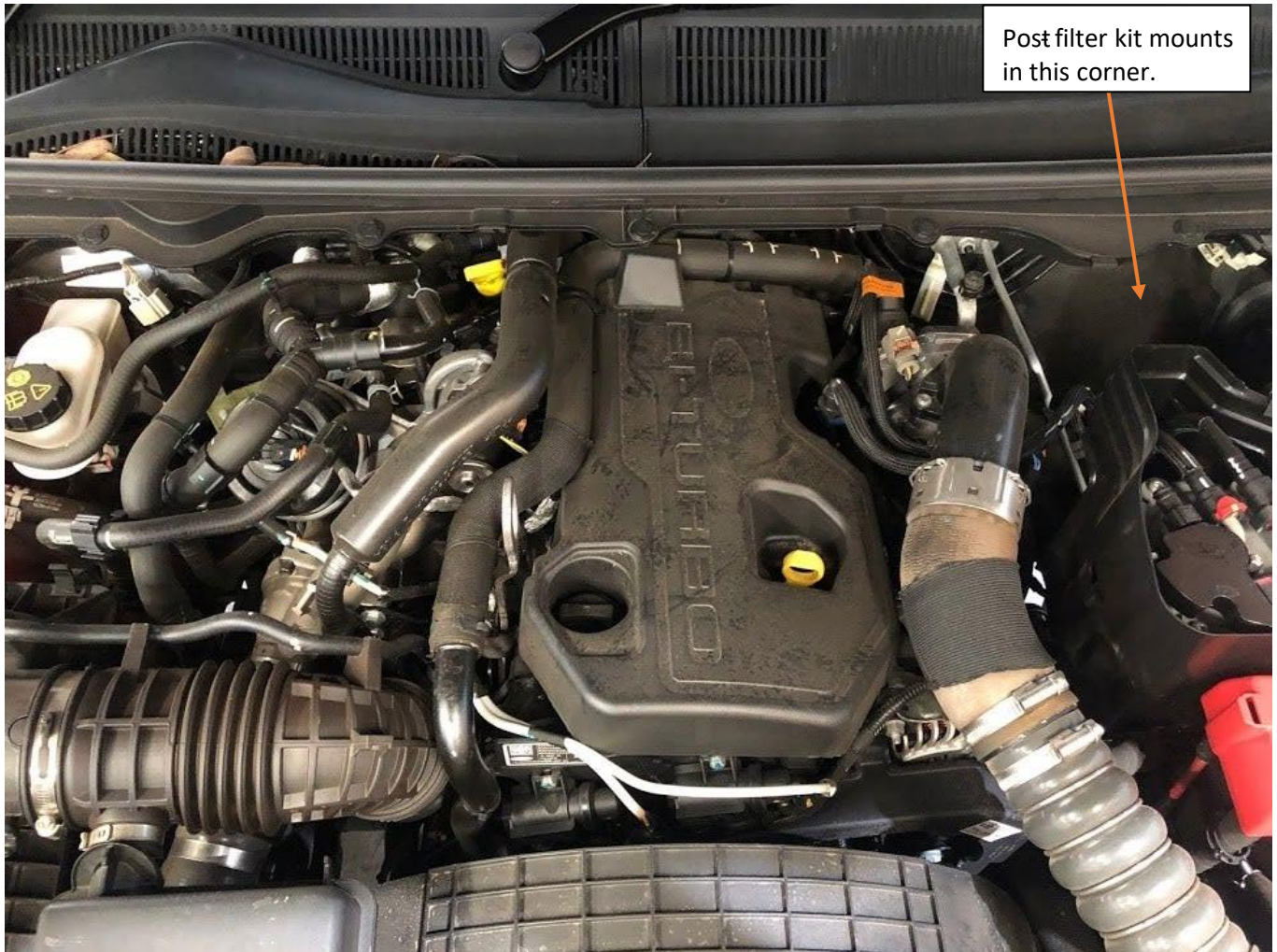

Ranger PXIII Engine Bay – Overall View

1. Locate the 2x M6 nuts located on the factory fuel filter bracket. They will need to be removed to allow fitment of the new bracket. You will also need to remove the bolt that retains the ABS unit nearby, the brace secures to this and the factory bolt gets reused.

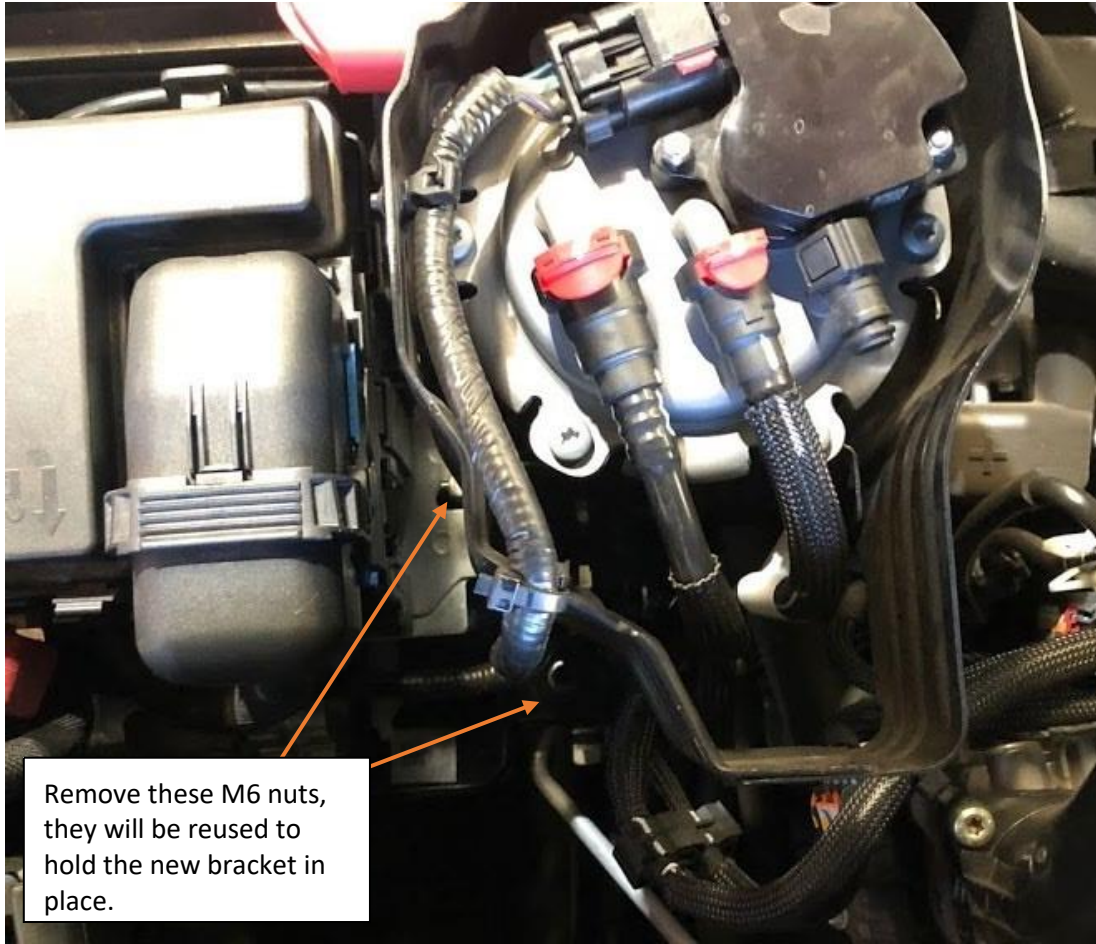

Top down view: image shows bracket mounting location

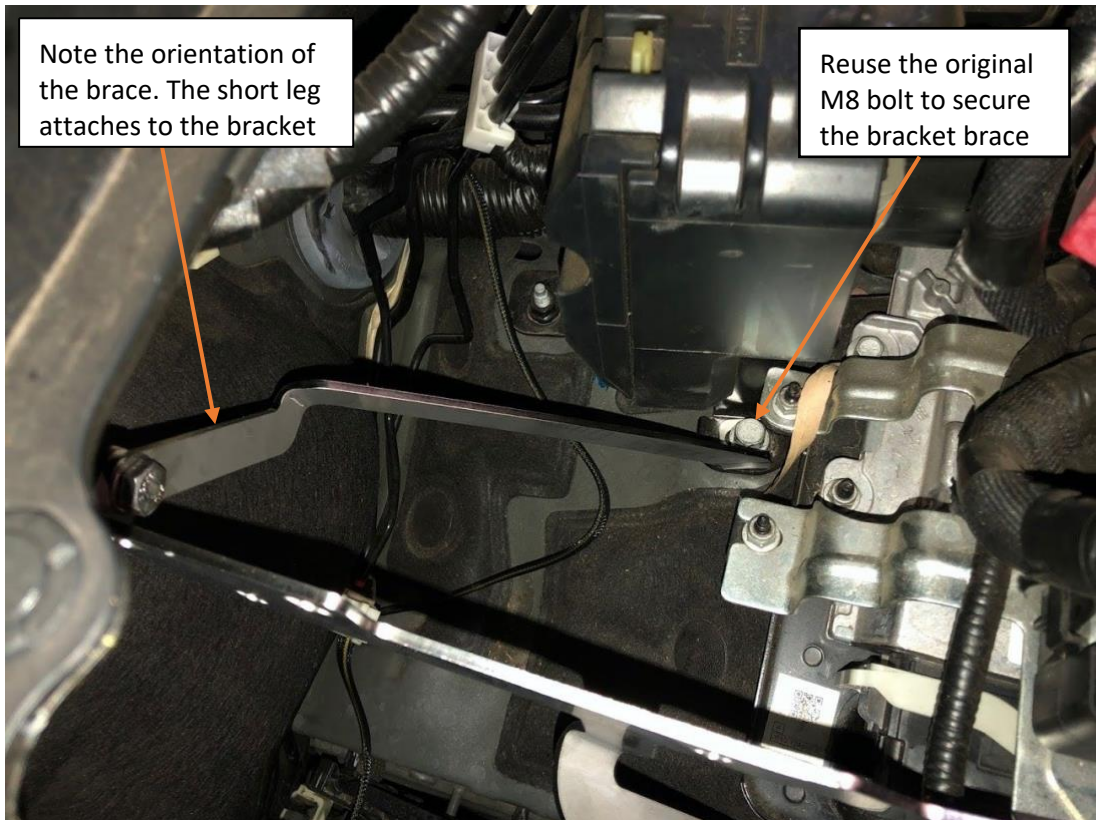
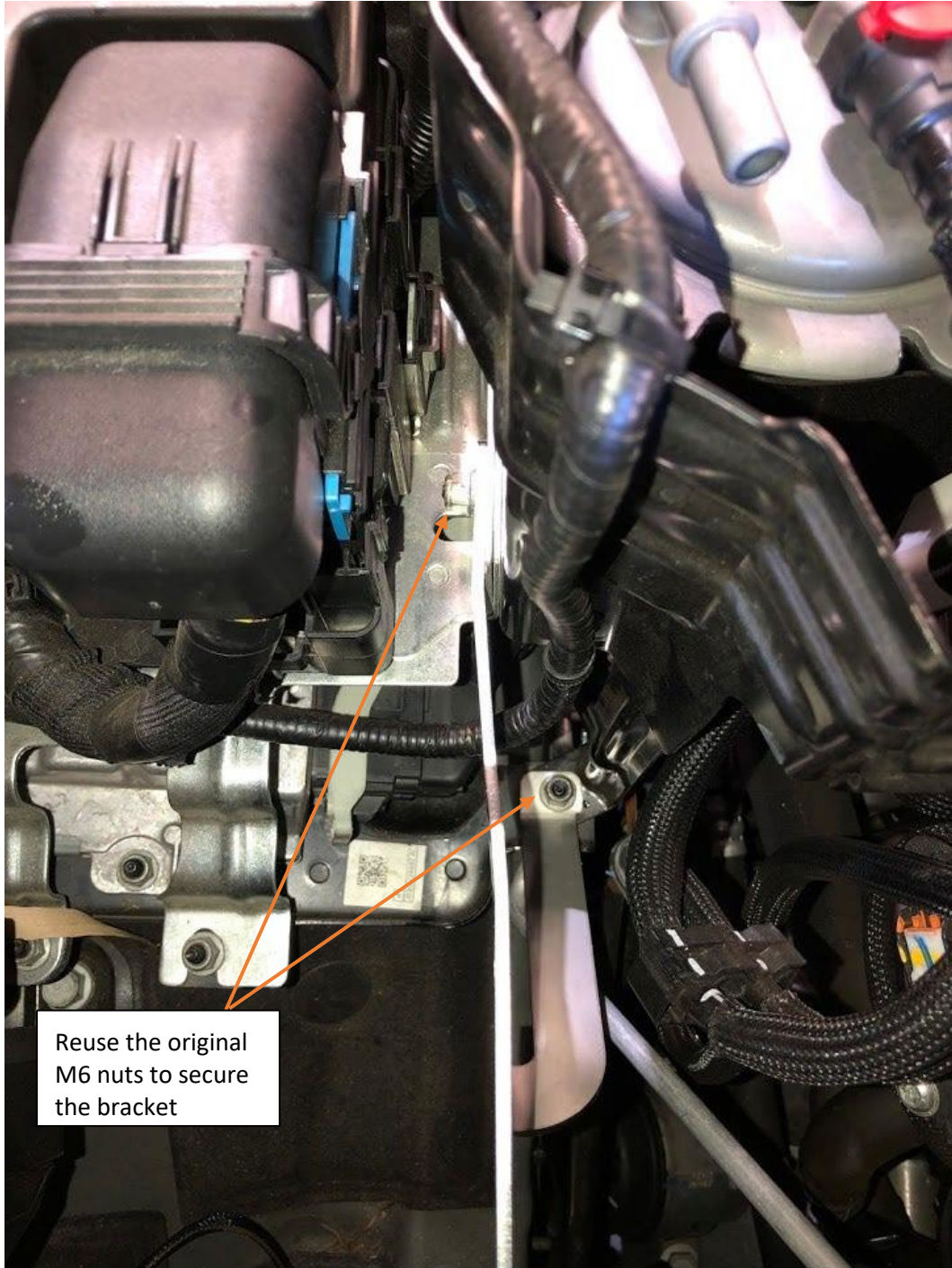

Image shows the rear mounting point and brace orientation

2. Bolt the Brackets into place using the M6 stud from the previous step to locate. Then use the M6 bolt, spring washer and mud washer on the leg to the existing empty threaded hole on the vehicle. Lastly, bolt the brace in place and secure the two brackets together using the M8x16 bolt, two flat washers, a spring washer and M8 nut. The bracket when in place should look like the picture below.



3. Install the NPT adapters and flat washers to the inlet and outlet ports that are facing toward the front of the vehicle when the Post-filter is installed.

Note: depending on installation you may need to remove and reposition the already installed plugs

4. Mount the Fuel Manager Post-filter assembly to the mounting bracket using the 2 x 10mm x 30mm bolts, 2 x 10mm flat washers.



5. Remove the RED quick disconnect fitting from the original filter head (the smaller fitting) and the other end from the inlet of the common rail supply pump. You will require a sharp knife to cut along the length of the nylon hose to remove it from the pipe. Remove the factory piece of pipe.

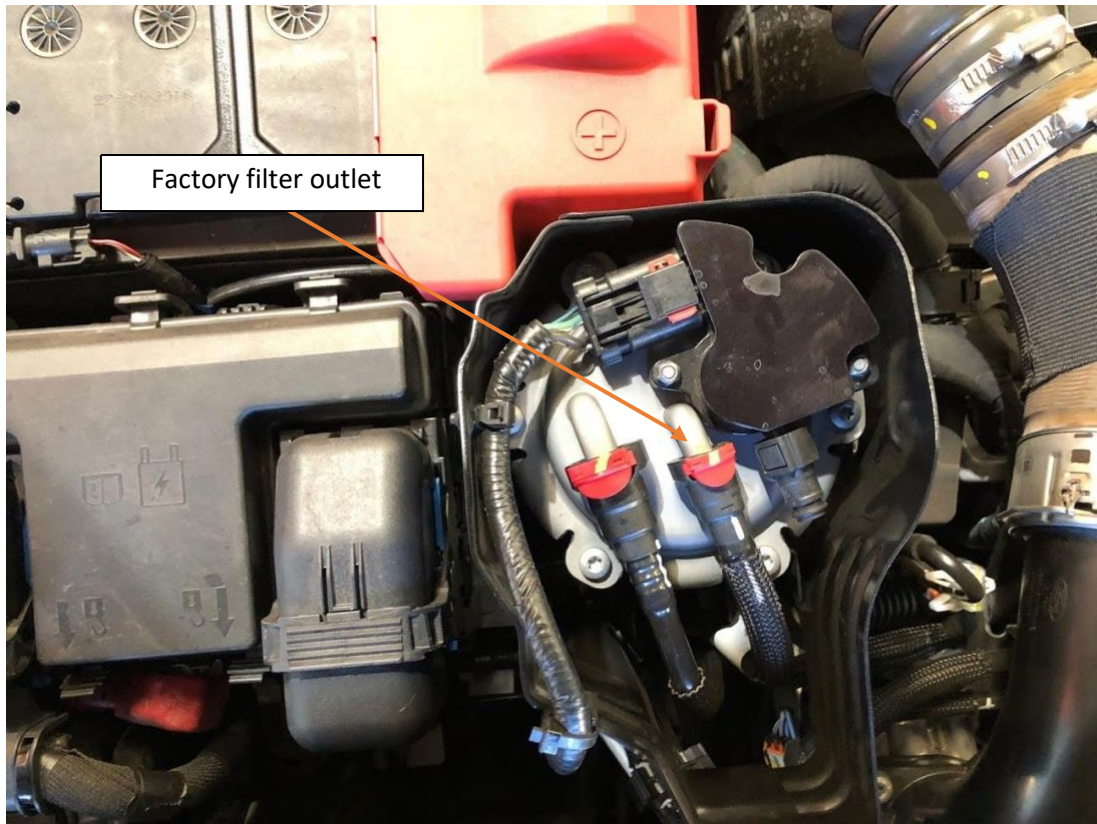

6. Using a knife remove the quick disconnect fitting from the nylon pipe by cutting along the length on the hose.

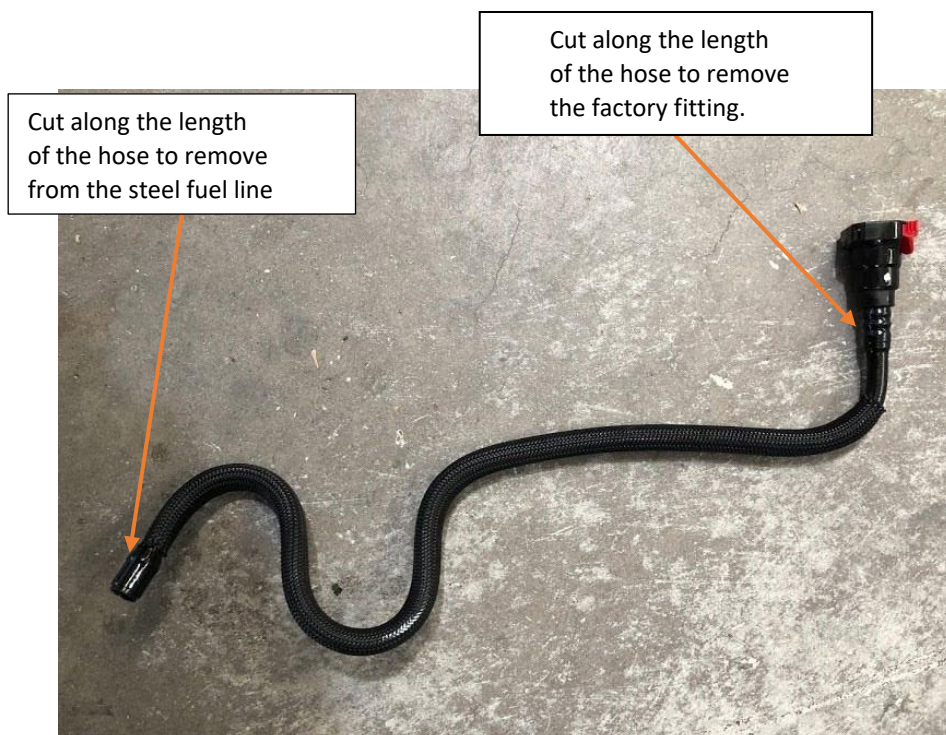

7. With one end of the supplied 10mm fuel hose, Lubricate the inside portion of one end using diesel fuel or WD40
8. Install one of the 10mm straight push-lock fittings into the pre-lubricated end of the 10mm fuel hose, ensuring that the hose stops firmly against the inside of the bell cover.
9. Connect the 10mm straight push-lock fitting to the outlet of the Post-filter housing. Adjust the angle of the fitting tail to clear any obstructions.
10. Route the 10mm fuel hose down to the inlet of the common rail supply pump and cut the hose to length approximately 25mm past.
11. Connect the hose coming from the outlet of the Post-filter to the inlet of the common rail supply pump and secure with a hose clamp.
12. With the remaining length of 10mm fuel hose Lubricate the inside portion of one end using diesel fuel or WD40.
13. Install the last 10mm push-lock fitting into the pre-lubricated end of the 10mm fuel hose, ensuring that the hose stops firmly against the inside of the bell cover.
14. Run the fuel hose up to the factory fuel filter outlet and trim to length.
15. Connect the other end of the hose coming from the Post-filter inlet to the quick disconnect fitting removed from the factory nylon fuel hose and secure with a clamp

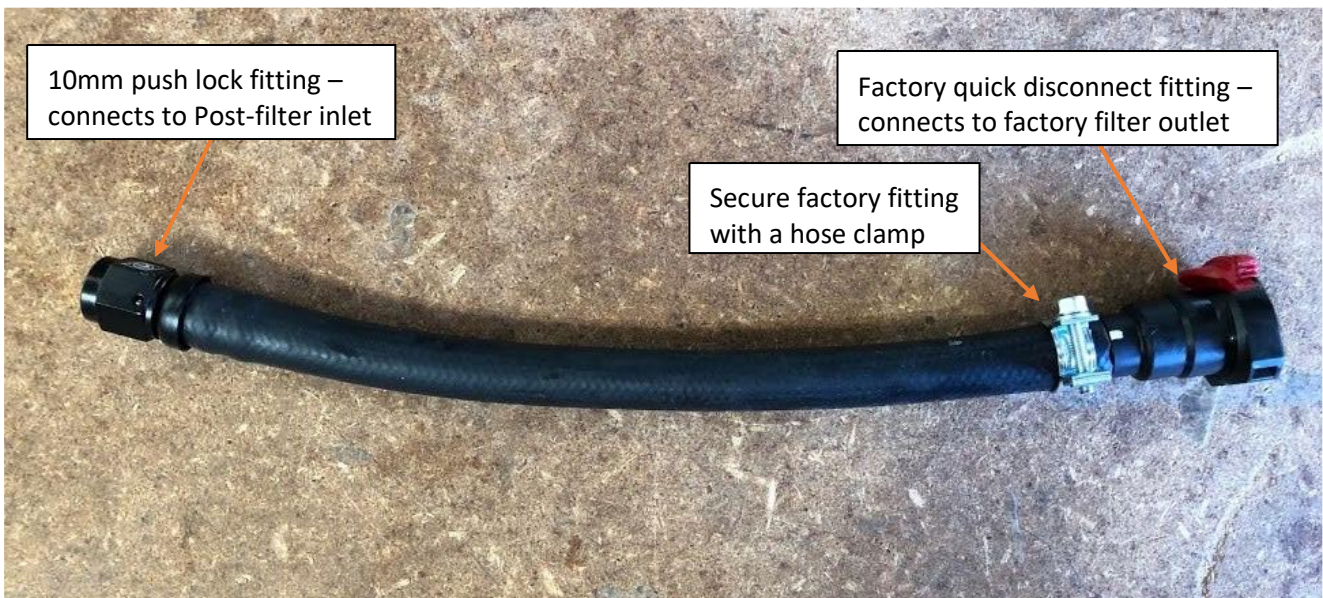

hose construction from Post-filter outlet to factory filter inlet

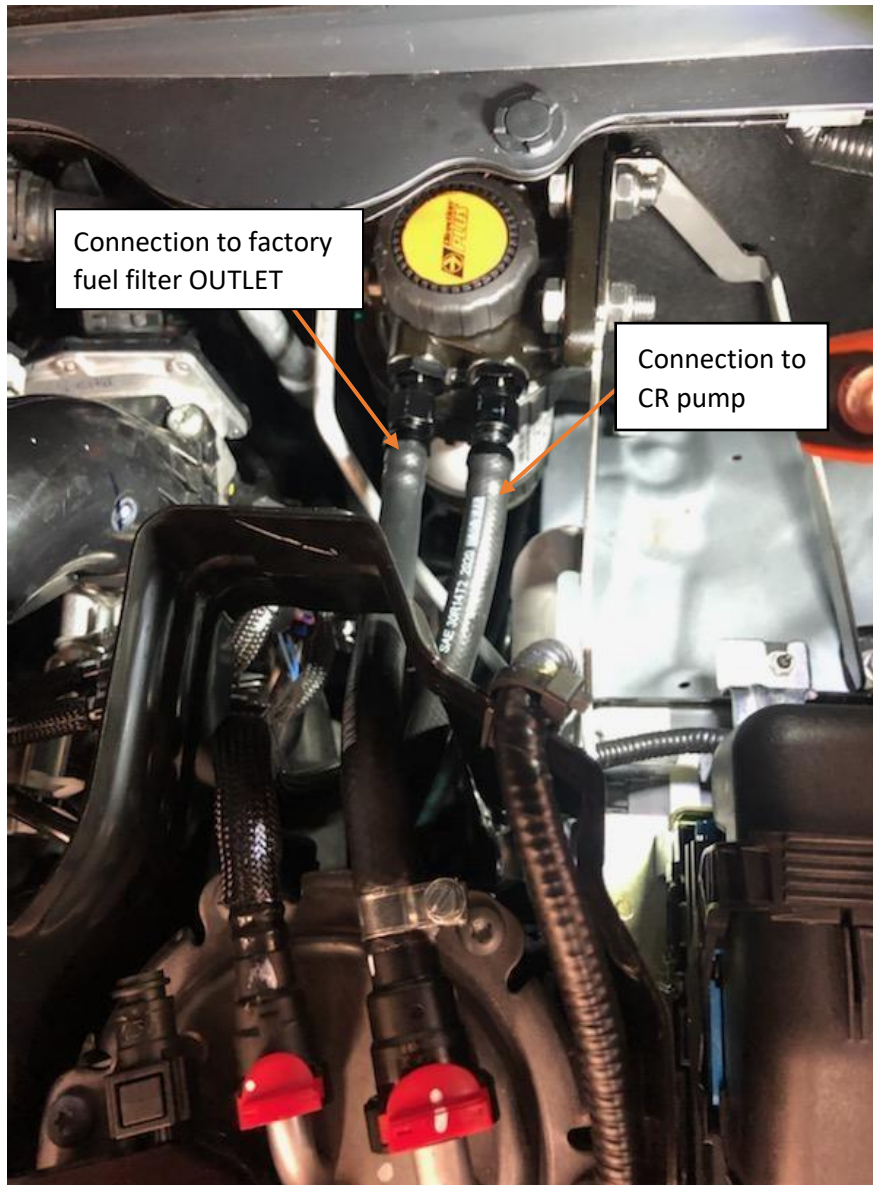

16. Using the supplied nylon cable ties carefully secure both fuel hoses, ensuring they are not kinked and cannot contact any hot components.
17. Remove any loose tools from the work area
18. Prime fuel system by turning the ignition key ON and allow the system to prime for approximately 30-60 seconds, repeat 4-6 times. You should hear the fuel pump running then switch off every time you turn the ignition on.
19. Start and run the vehicle checking for leaks – if the vehicle stalls repeat step 20



Completed installation of the Fuel Manager POST-FILTER PF664DPK

End of Installation Guide

